

Note:

THE SIGNAL BOOSTER UNIT IS DESIGNED FOR USE IN AN INDOOR, TEMPERATURE-CONTROLLED ENVIRONMENT (LESS THAN 150 DEGREES FAHRENHEIT). IT IS NOT INTENDED FOR USE IN ATTICS OR SIMILAR LOCATIONS SUBJECT TO TEMPERATURES IN EXCESS OF 150°F.

IT IS VERY IMPORTANT TO POWER YOUR SIGNAL BOOSTER USING A SURGE PROTECTED AC POWER STRIP WITH AT LEAST A 1000 JOULE RATING. FAILURE TO DO THIS WILL VOID YOUR WARRANTY IN THE EVENT OF A POWER SURGE OR LIGHTNING STRIKE.

How It Works

Your cell phone is an essential part of your life. weBoost is here to ensure you have seamless connections on all your cellular devices.

The Drive 3G-FLEX cellular signal booster is a effective solution to all those times you have lost a call while driving your vehicle due to a weak cell signal. Installation is simple and can be completed with minimal tools.

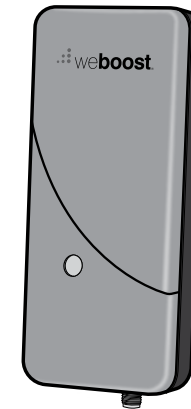
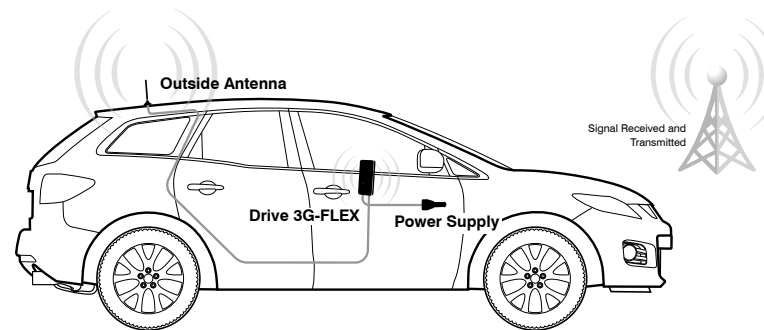

Drive 3G-FLEX Quick Install Guide

For more information refer to full Install Guide at:
www.weboost.com/us/installguide/drive3G-FLEX

Product Registration

Thank you for purchasing this weBoost product. Please take time to register your new product at our website:

www.weboost.com/us/productregistration

Registering is quick and easy, it only takes 2-3 minutes to complete. Your information is secure, we don't share or sell your information to other third parties.

This device complies with part 15 of the FCC Rules. Operation is subject to the following two conditions: (1) This device may not cause harmful interference, and (2) This device must accept any interference received, including interference that may cause undesired operation.

RF Safety: Any antenna used with this device must be located at least 8 inches from all persons.

FCC ID: PWO460013 IC: 4726A-460013



3301 East Deseret Drive, St. George, UT 84790

web: www.weboost.com | email: support@weboost.com

phone: 866-294-1660 | local: 435-673-5021 | fax: 435-656-2432



111568_Rev02_01.30.15

NEED ASSISTANCE? WE CAN HELP!

Contact our U.S.-BASED CUSTOMER SUPPORT:

- Contact our U.S.- based customer support team at 1-866-294-1660 or email at support@weboost.com
- Go online for how to resolve the most common issues at www.weboost.com/us/support
- Find a weBoost Installer on our web site at www.weboost.installernet.com

Installation is simple, but we're here to make it even easier.

Package Contents

Drive 3G-FLEX
Mini-Magnet Antenna

AC/DC Power Supply
USB Cable w/Power Adapter

Antenna Window Mount
Dash Mounting Kit

Quick Install Diagram

Outside Antenna Installation

Running Antenna Cable

Connect Cable to Drive 3G-FLEX / Power Supply Cord

Connect Power Supply

Mount Dash Bracket

1 Outside Antenna Installation

Select a location on top of the vehicle to mount the Mini-Mag Mount Antenna that is:

- Near the center of the vehicle's roof.
- Free of obstructions.
- At least 12 inches from any other antennas.
- At least 6 inches from any windows (including sunroofs).

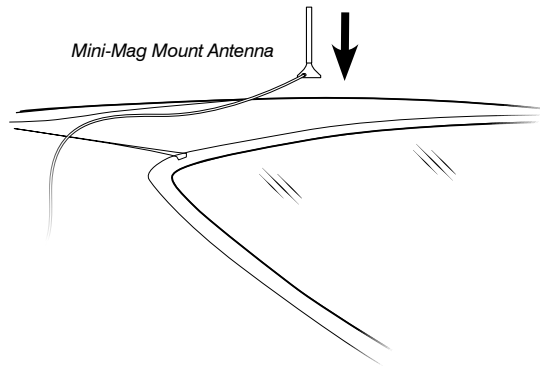

2 Running Antenna Cable

Run the Outside Antenna cable into the car. The cable is strong enough that it may be shut in most vehicle doors without damaging the cable. For a cleaner look, carefully pull down the door seal, run the cable under the seal, and push the seal back into place. This method reduces wear on the cable as the door opens and closes.

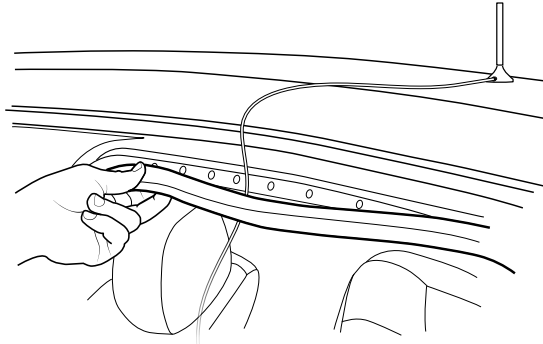

3 Connect Coax Cables to Drive 3G-FLEX

Connect the cable from the Mini-Mag Mount Antenna to the port labeled "Antenna" on the Drive 3G-FLEX.

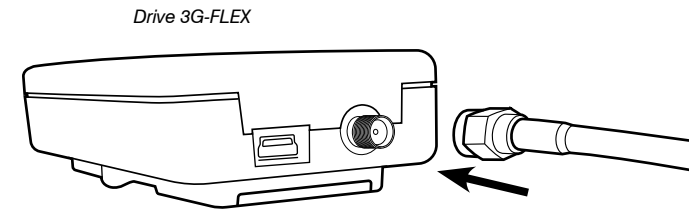

4 Connect Power Supply to Drive 3G-FLEX

Connect the power cable to the mini-USB port on the bottom of the Drive 3G-FLEX.

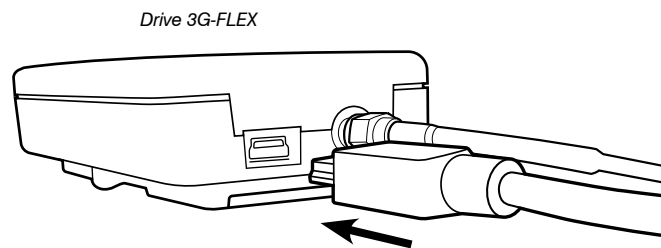

5 Connect to Power Supply

Plug the power adapter into vehicle's 12V DC power supply. If your Drive 3G-FLEX is working correctly, the lights will be green.

NOTE: If lights are not green, please refer to the full install guide online or contact customer support at 1-866-294-1660 or email at support@weboost.com.

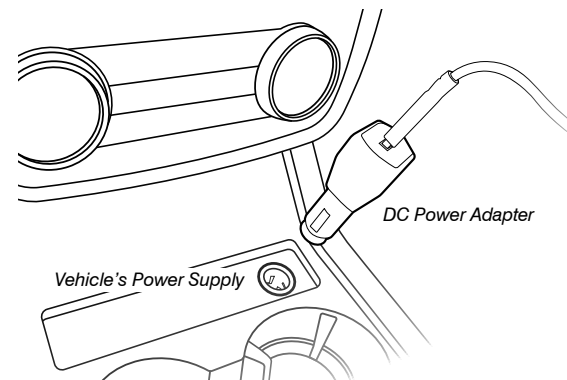

6 Mount Dash Bracket (optional).

Clean the area where the bracket is to be mounted with the alcohol wipe included. Allow the area to dry. Peel the backing to expose the adhesive and press the bracket onto the desired location on the dashboard.

